

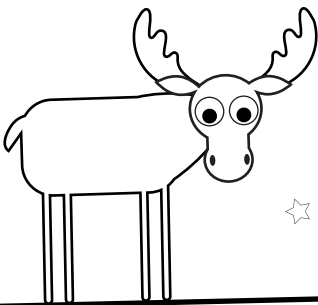

# Summer of Possibilities

# Exploring Space

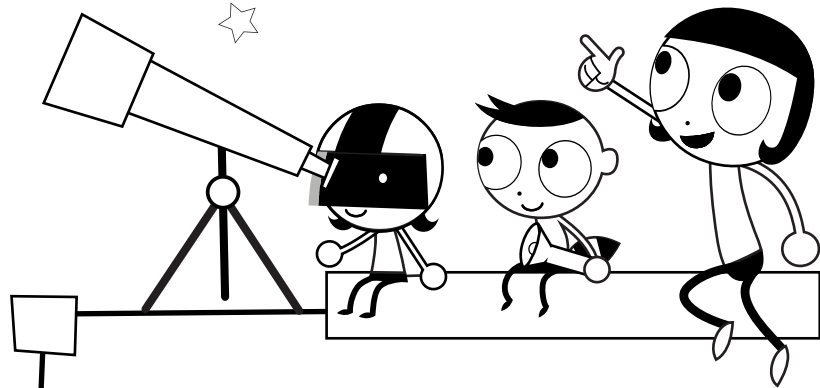



# Summer Activities for Families



Play and learn this summer with PBS KIDS! Get started with the hands-on activity collections below or visit [pbskids.org](http://pbskids.org), the PBS KIDS Video app, and the PBS KIDS Games app for more ideas and fun. Remember to follow @PBSKIDS for great summertime activities for the whole family.

## EXPLORE

SUMMER COLLECTIONS

## PLAY & LEARN

FREE ACTIVITIES ON [pbskidsforparents.org/summer](http://pbskidsforparents.org/summer)

## CELEBRATE WITH FAMILY NIGHT

FRIDAYS ON THE PBS KIDS 24/7 CHANNEL AND VIDEO APP



### Observing Nature

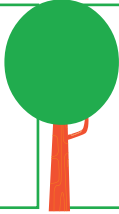

You and your child can try a scavenger hunt, go on a weather walk, or read and play with this nature-themed playlist and activity collection. What's the biggest tree you can find?

Tally Ho! Nature Cat, Hal, Daisy, and Squeeks are hitting the trails to learn about birds, bugs, and...strawberries? Tune in for a sweet NATURE CAT marathon June 4.

### Making Family Traditions

Does your family have a favorite tradition? Get inspired to create your own with this collection of crafts, music, and story clips.

Join Molly, Tooeey, and Trini for a night of adventure as they explore family stories, Alaska Native traditions, and the great outdoors in MOLLY OF DENALI. Tune in on June 11.

### Sharing Your Creativity through Art

Spark creativity with games from SCRIBBLES AND INK! This special collection of resources is designed to get you and your child singing, dancing, drawing, and laughing.

It's a pinka-party and your family is invited to paint, draw, and dance with PINKALICIOUS & PETERRIFIC! Join the fun on June 18.

### Being a Good Friend and Neighbor



What makes family and friends special? There are lots of things kids can do to celebrate neighbors and friends. This collection will help them learn about their role in the community.

There's a new neighborhood at PBS KIDS! It's the world of DONKEY HODIE from the makers of DANIEL TIGER'S NEIGHBORHOOD. Tune in June 25 to see how Donkey Hodie and her pals use teamwork and laughter to accomplish amazing things.

### Exploring Space at Home

Build a rocket ship, go stargazing, or imagine life on another planet with this collection of space-themed games, activities, and an out-of-this-world playlist.



Jet Propulsion is the kid next door AND an alien! Join him - along with his family and friends - as they explore the far reaches of outer space in two specials from READY JET GO! on July 2.



[pbskidsforparents.org/summer](http://pbskidsforparents.org/summer)



# Summer Activities for Families



## EXPLORE

SUMMER COLLECTIONS

## PLAY & LEARN

FREE ACTIVITIES ON [pbskidsforparents.org/summer](https://pbskidsforparents.org/summer)

## CELEBRATE WITH FAMILY NIGHT

FRIDAYS ON THE PBS KIDS 24/7 CHANNEL AND [VIDEO APP](#)

### Playing with Water

Whether it's frozen or melted, water is a wonderful way to inspire your child's curiosity. Find playful activities in this water-themed collection.



### Investigating Animals

Crawl like an ant, jump like a frog, and gallop like a horse! Inspire young learners to sing, play, and laugh with this special collection of animal-themed resources.



### Reading and Sharing Stories

Words can take your child anywhere. Use the activities in this collection to help them build literacy skills and create and share family stories.

Get ready to travel through time with XAVIER RIDDLE AND THE SECRET MUSEUM! The fun starts on July 23 when Xavier, Yadina, and Brad meet real-life storytellers Mark Twain, Zora Neale Hurston, and Maya Angelou.

### Creating Daily Routines for Kids

It's always a good time to brush up on everyday routines with your child like greeting friends, picking up toys, and getting ready for bed. This collection is filled with tips and ideas!



It's scary and exciting to do something for the first time. Pick up tips, songs, and strategies from Daniel as he explores new things during the DANIEL TIGER'S NEIGHBORHOOD marathon on July 30.

### Going Back to School

Preparing for a new school year can stir up lots of emotions for your child. Use the activities in this collection to plan ahead and practice first day routines together.

"That is so interesting!" Everyone wonders about the world, including Elinor from ELINOR WONDERS WHY. She's curious just like your child! Join her on August 6 as she learns to ask questions and solve puzzles.

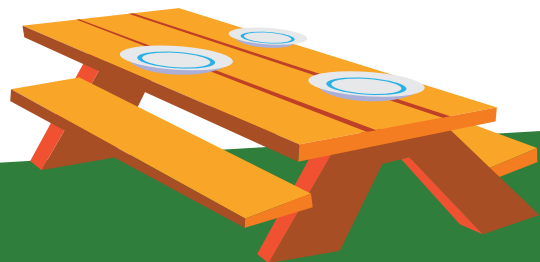

[pbskidsforparents.org/summer](https://pbskidsforparents.org/summer)

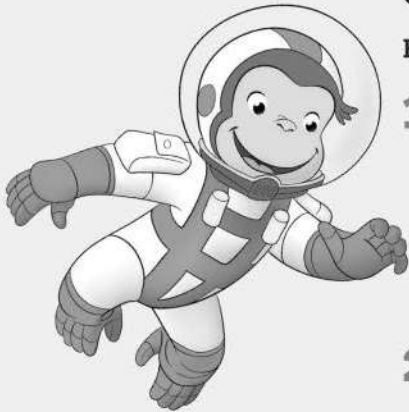

## Space Monkey Blast Off!

Build a rocket and launch Curious George into space!

### 1. Build a Rocket

- Flatten the tip of one end of the short wide straw with your fingers. Seal with tape.
- Cut out one of George's rockets (below) and fold in half.
- Tape the rocket to the sealed end of the straw.

### 2. Launch It!

- Place the open end of George's rocket over the thin straw.
- Aim the rocket upwards, and blow into the bottom of the thin straw. Watch it fly!
- How do you launch your rocket if you want it to go far? How do you launch it if you want it to go high?

### 3. Test a Different Design

- What will happen if you change the design of your rocket? Make a prediction, then test it out.
- Try launching your rocket with a paperclip attached to the top of it.
- Then try the rocket without the paperclip.
- Which design flies farther? Why do you think that is? What does testing help you discover about your rocket?



#### Materials

wide straw, cut into thirds

thinner straw, full length

tape

scissors

Curious George rocket cut-out, folded in half

paper clips

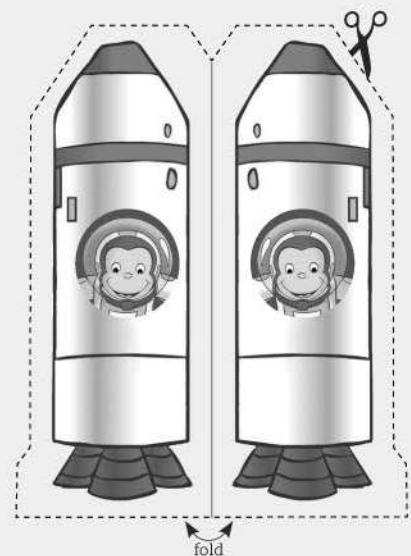
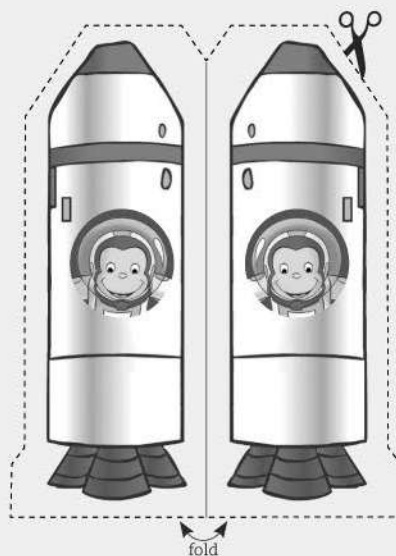
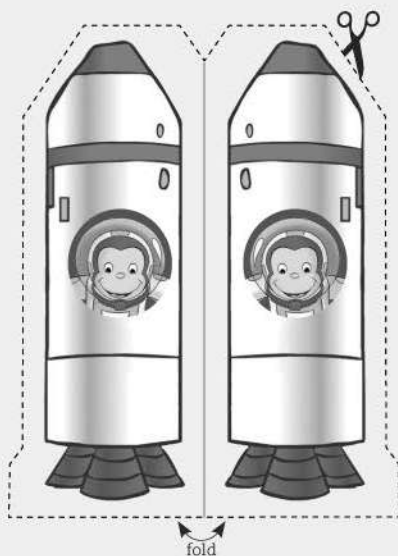

For more games and activities, visit [pbskidsforparents.org](http://pbskidsforparents.org)



# Design Your Own Telescope

- \* Color this page and ask a grown-up to help cut along the dashed lines.
- \* Wrap it around a paper tube and then tape the edges of the sheet together.
- \* Use your new telescope to look at the moon, stars, or objects around you!
- \* Make a map of what you found.

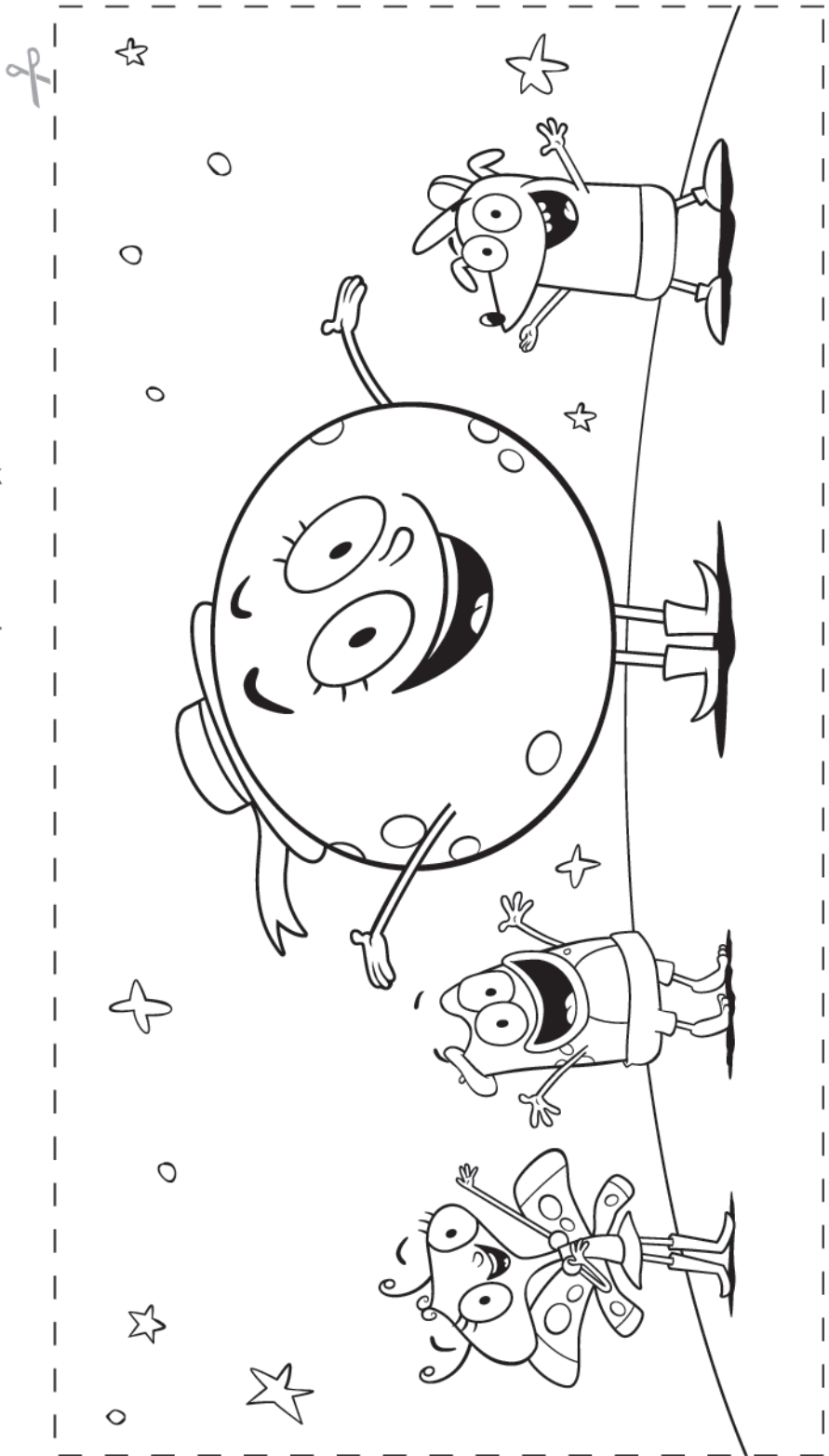

Find more games and activities at [pbskidsforparents.org](http://pbskidsforparents.org)

Produced by:



Sponsored by:





# Moon Journal

Name \_\_\_\_\_

Did you know that the moon doesn't actually change shapes? This "change" is really the shadow of the Earth as it blocks the Sun's light from reaching the Moon. From Earth, the moon will appear to have different shapes depending on where it is in the Earth's orbit.

## Look up at the moon each night at the same time and draw what you see!

Date observations started: \_\_\_\_\_ Time to Check Moon Each Night: \_\_\_\_\_

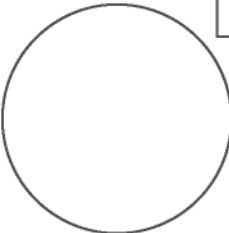
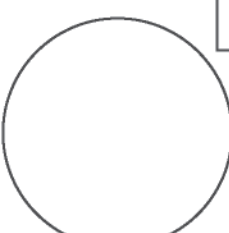
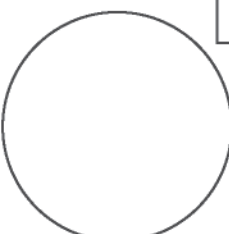
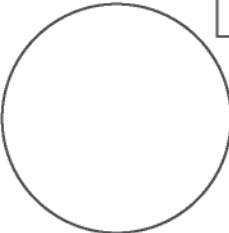
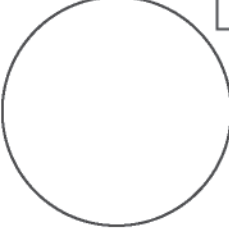
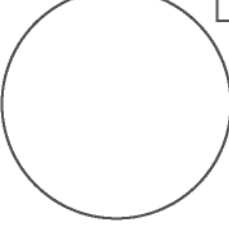
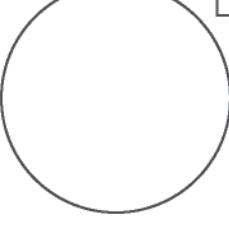
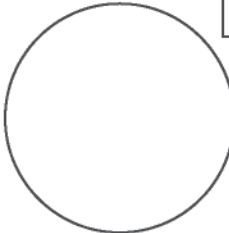
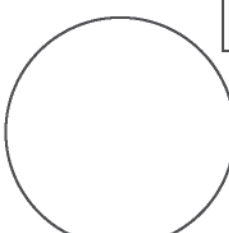
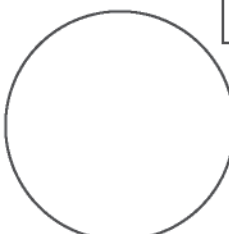
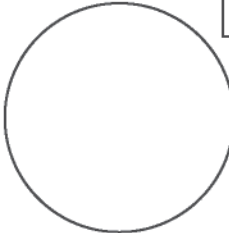
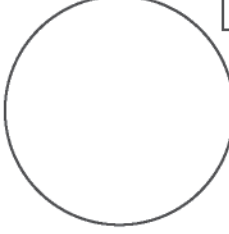
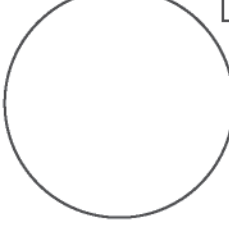
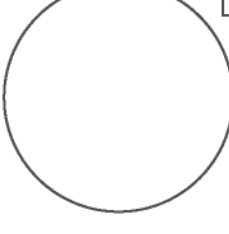
Sunday	Monday	Tuesday	Wednesday	Thursday	Friday	Saturday
 Date: _____	 Date: _____	 Date: _____	 Date: _____	 Date: _____	 Date: _____	 Date: _____
 Date: _____	 Date: _____	 Date: _____	 Date: _____	 Date: _____	 Date: _____	 Date: _____

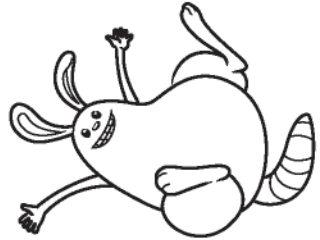

New Moon

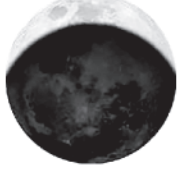

Waxing Crescent



First Quarter



Waxing Gibbous



Full Moon



Waning Gibbous

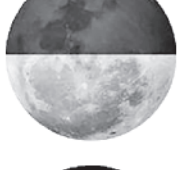

Last Quarter

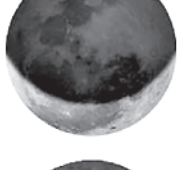

Waning Crescent

Produced by:



Funded by:



For more games and activities, visit [pbskidsforparents.org](http://pbskidsforparents.org)

Sponsored by:



The contents of this document were developed under a cooperative agreement (PR/Award No. U295A150003, CFDA No. 84.295A) from the U.S. Department of Education. However, these contents do not necessarily represent the policy of the Department of Education, and you should not assume endorsement by the Federal Government. © 2018 Jet Propulsion, LLC. Ready, Jet Go! and the Ready, Jet Go! logo are registered trademarks of Jet Propulsion, LLC. The PBS KIDS logo and PBS KIDS © PBS. Used with permission. Corporate Funding of Ready, Jet Go! is brought to you by ABCmouse.com. Made available by the Corporation for Public Broadcasting, a private corporation funded by the American people.



# Flashlight Constellations

A constellation is a series of stars that form a picture in the sky. Astronomers use it today to help pinpoint the locations of other stars. Ask an adult to help cut out the four constellations and punch small holes on each star. These points are the locations of the stars in each constellation.

Choose the size circle that fits on your flashlight lens, cutting along the inner or outer dashed circle. Flip the picture so it's facing the flashlight.

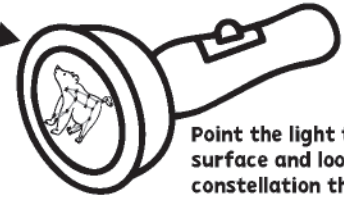

Point the light to a dark surface and look at the constellation that shines through. One at a time, identify each constellation and talk about how you identified them.

## URSA MAJOR

Ursa Major is also known as The Great Bear. Ancient Greeks tell the story about a beautiful girl named Callisto who was turned into a bear by a mean goddess. A tracker tried to catch the bear, but the Greek God Zeus saved Callisto by placing her up in the night sky where she was safe.



## URSA MINOR

The story of Ursa Minor, or The Little Bear, comes from the Ancient Greeks. Arcas was a great hunter. One day while hunting in the woods, he came across a great bear. Little did he know that was actually his mother, Callisto, who was under a spell. Arcas was about to catch the great bear, but the Greek god Zeus, stopped him just in time and turned Arcas into a little bear so he could be with his mom. Zeus placed the two bears into the sky to keep them safe and protected.

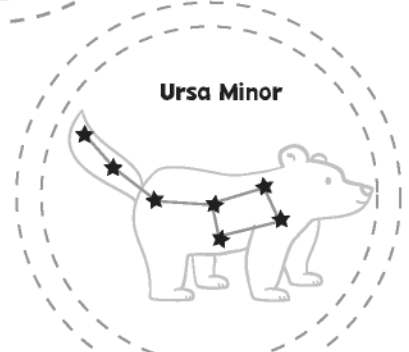

## LEO THE LION

In Greek myths, Leo the Lion lived outside an ancient city called Nemea. For many years, Leo would scoop up people from Nemea and no one would stop him. One day, Hercules went to stop the lion and won. Everyone who the lion had caught was set free. Zeus made Leo a constellation in the night sky to remind people of the story of Hercules and Leo.

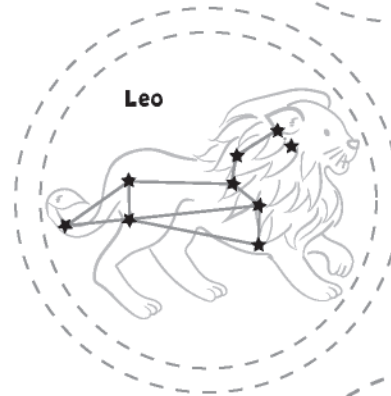

## TAURUS THE BULL

The Ancient Greeks tell the story of a wild bull named Taurus who had a bad temper. One day he trampled a field of wild flowers and Persephone, the Goddess of Spring, got very sad. Taurus apologized and they soon became good friends. From then on, every spring, Persephone would ride on Taurus' back and the two of them would make the flowers bloom as they walked by.

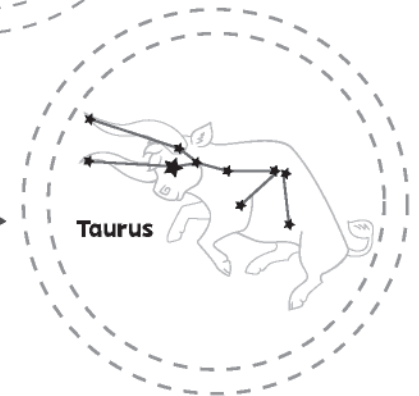



# Flashlight Constellations

## Constellation Key

### URSA MAJOR

#### The Great Bear

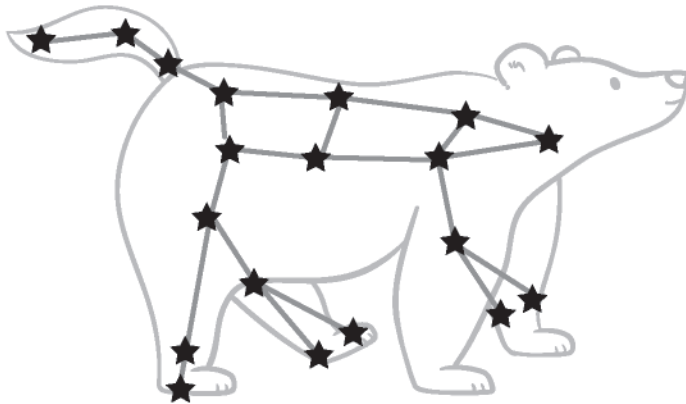

### URSA MINOR

#### The Little Bear

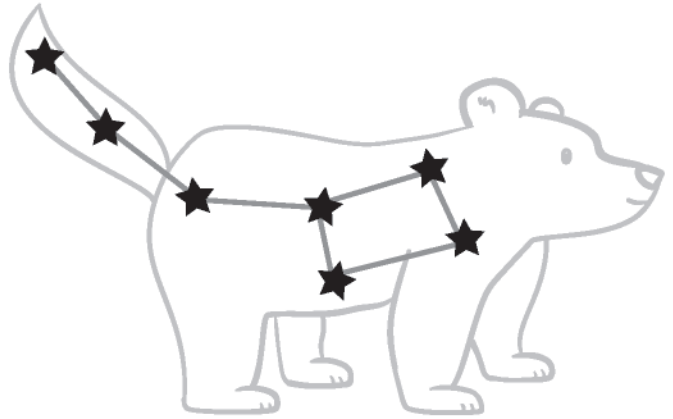

### LEO

#### The Lion



### TAURUS

#### The Bull

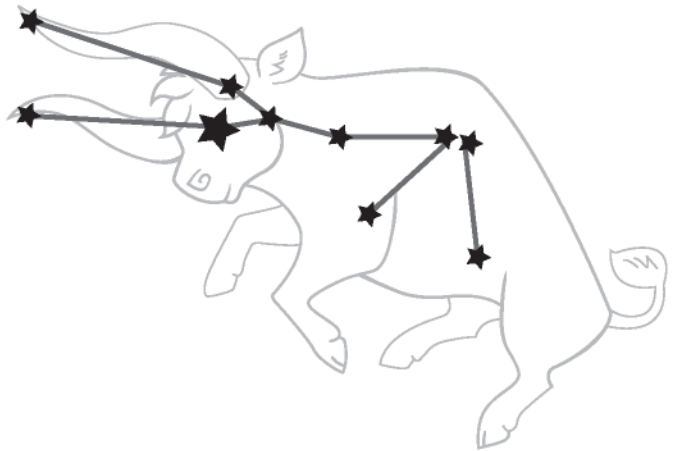





# Cosmic Combos

Create an alien invasion! Each of these aliens is divided into three parts: top, middle, and bottom. Print and color the aliens, then cut them into separate pieces. Mix and match the parts to make new creatures!

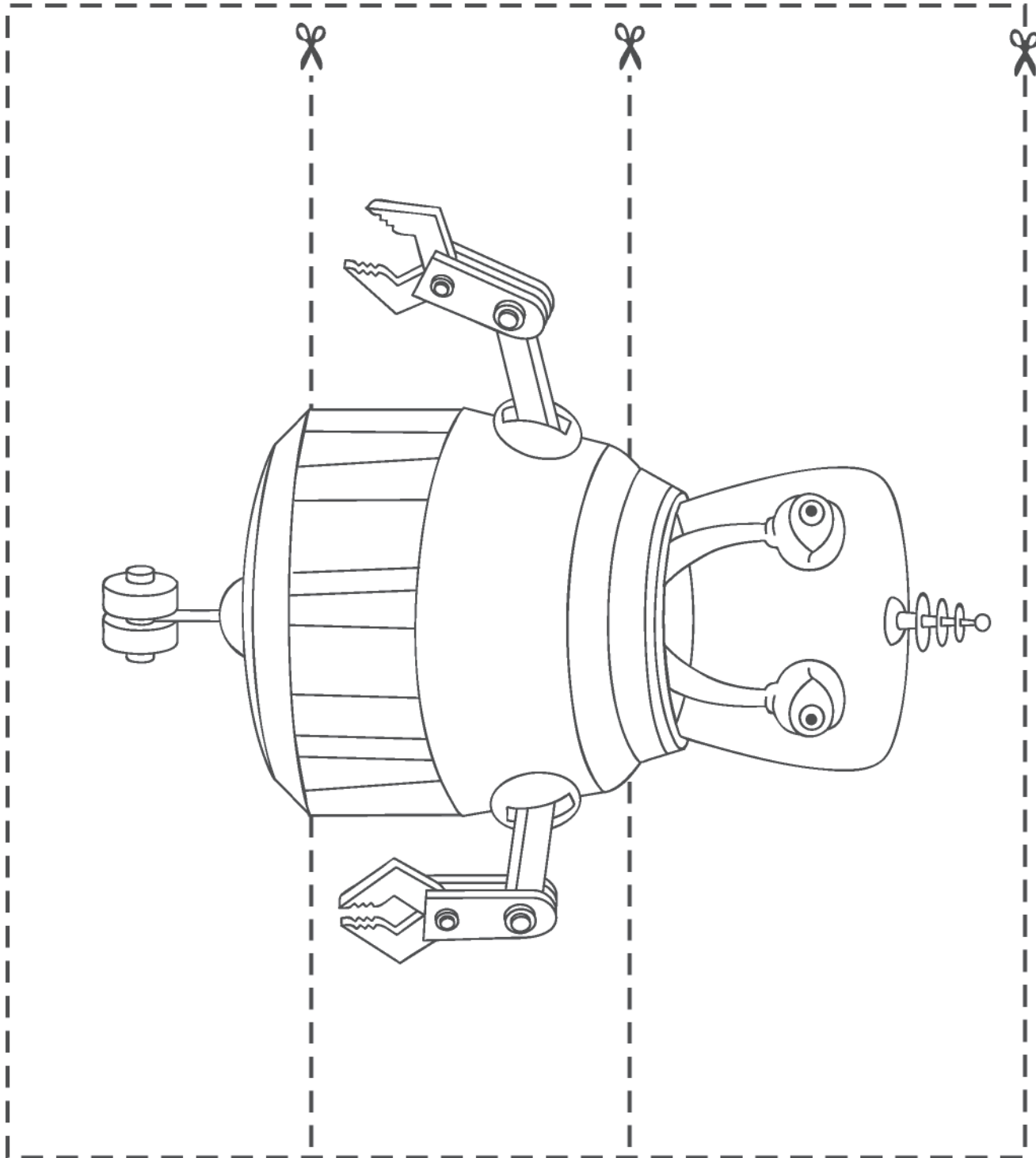



# Cosmic Combos

Create an alien invasion! Each of these aliens is divided into three parts: top, middle, and bottom. Print and color the aliens, then cut them into separate pieces. Mix and match the parts to make new creatures!

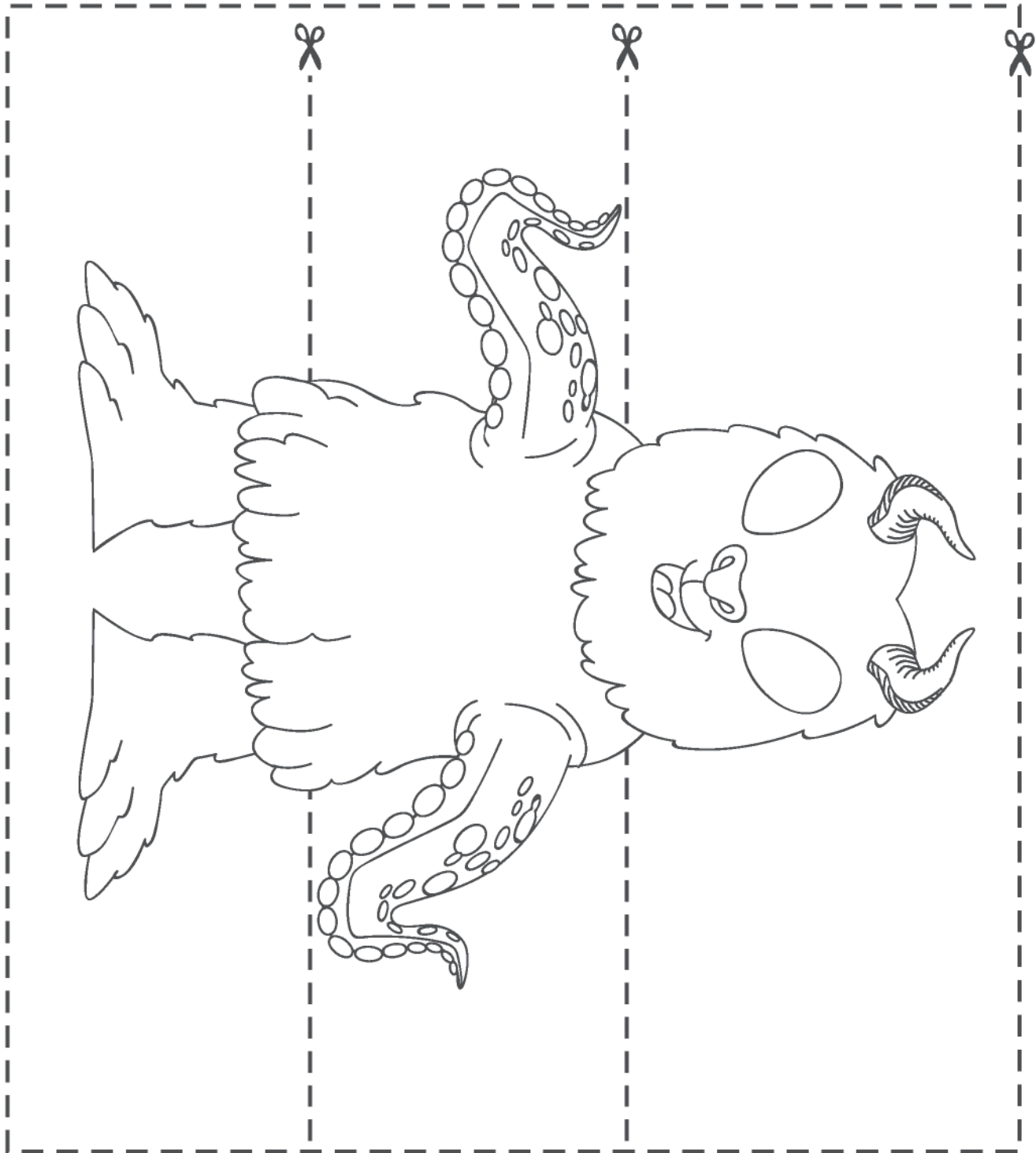



# Cosmic Combos

Create an alien invasion! Each of these aliens is divided into three parts: top, middle, and bottom. Print and color the aliens, then cut them into separate pieces. Mix and match the parts to make new creatures!

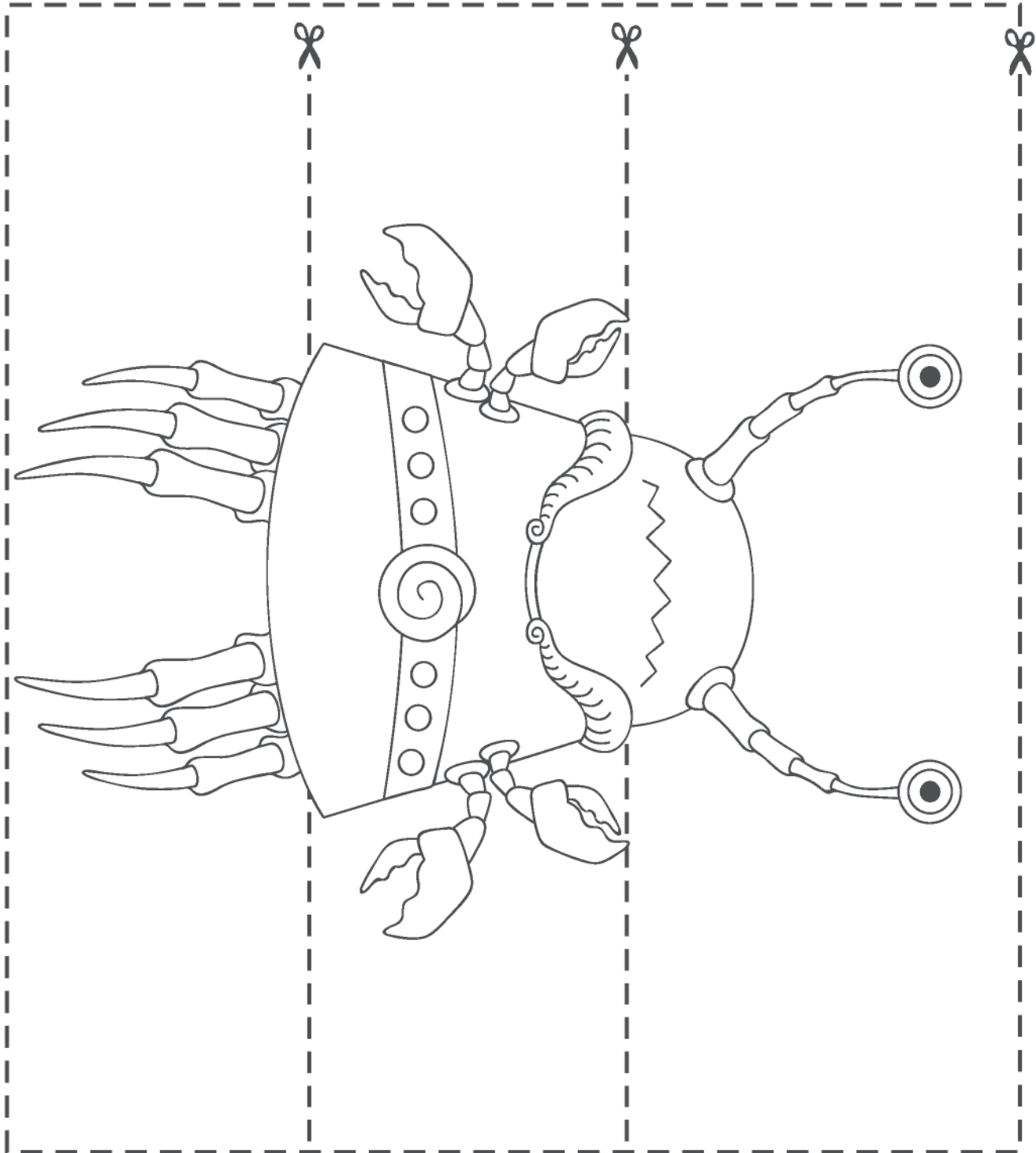



# Cosmic Combos

Create an alien invasion! Each of these aliens is divided into three parts: top, middle, and bottom. Print and color the aliens, then cut them into separate pieces. Mix and match the parts to make new creatures!

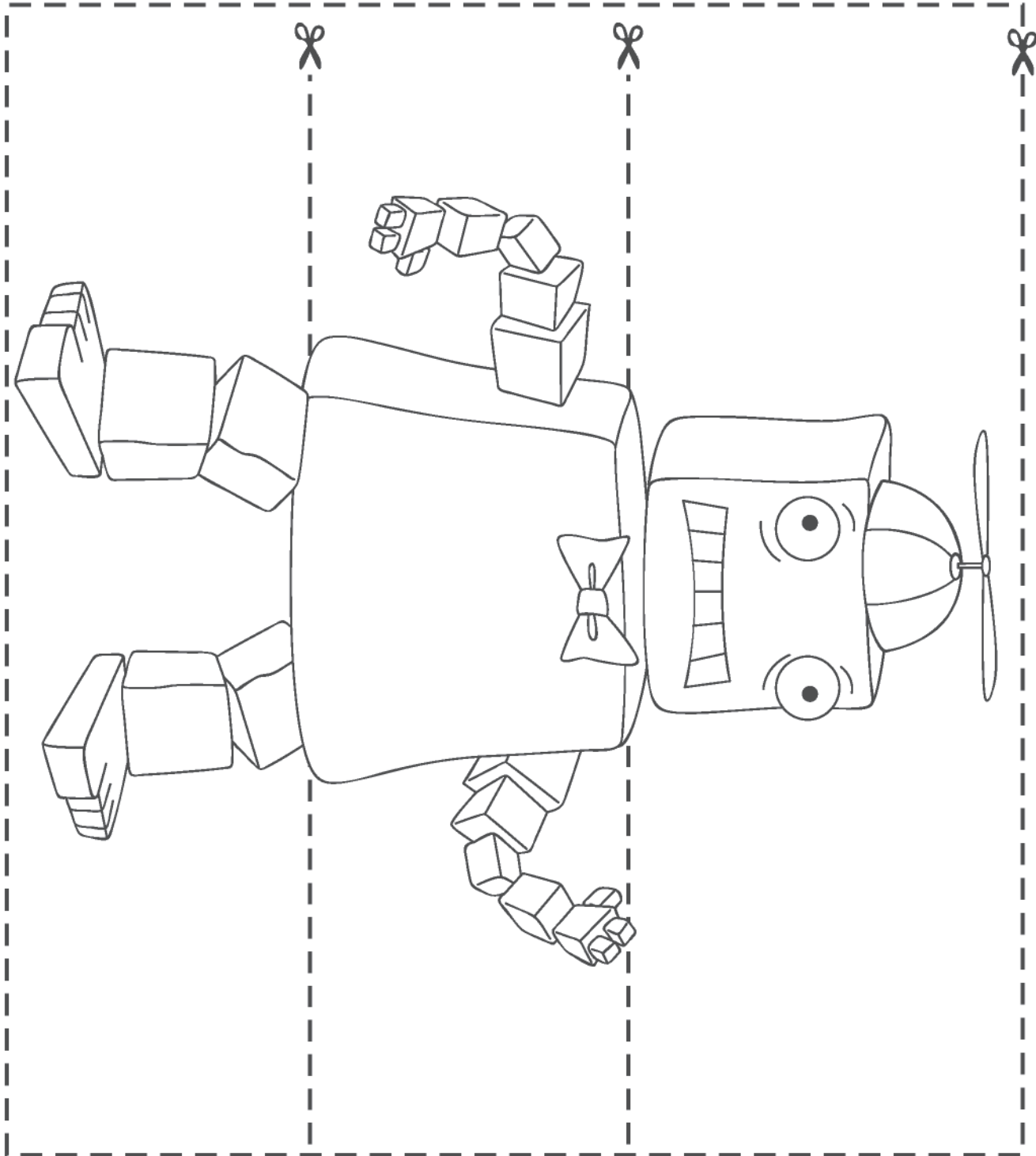



# Cosmic Combos

Create an alien invasion! Each of these aliens is divided into three parts: top, middle, and bottom. Print and color the aliens, then cut them into separate pieces. Mix and match the parts to make new creatures!

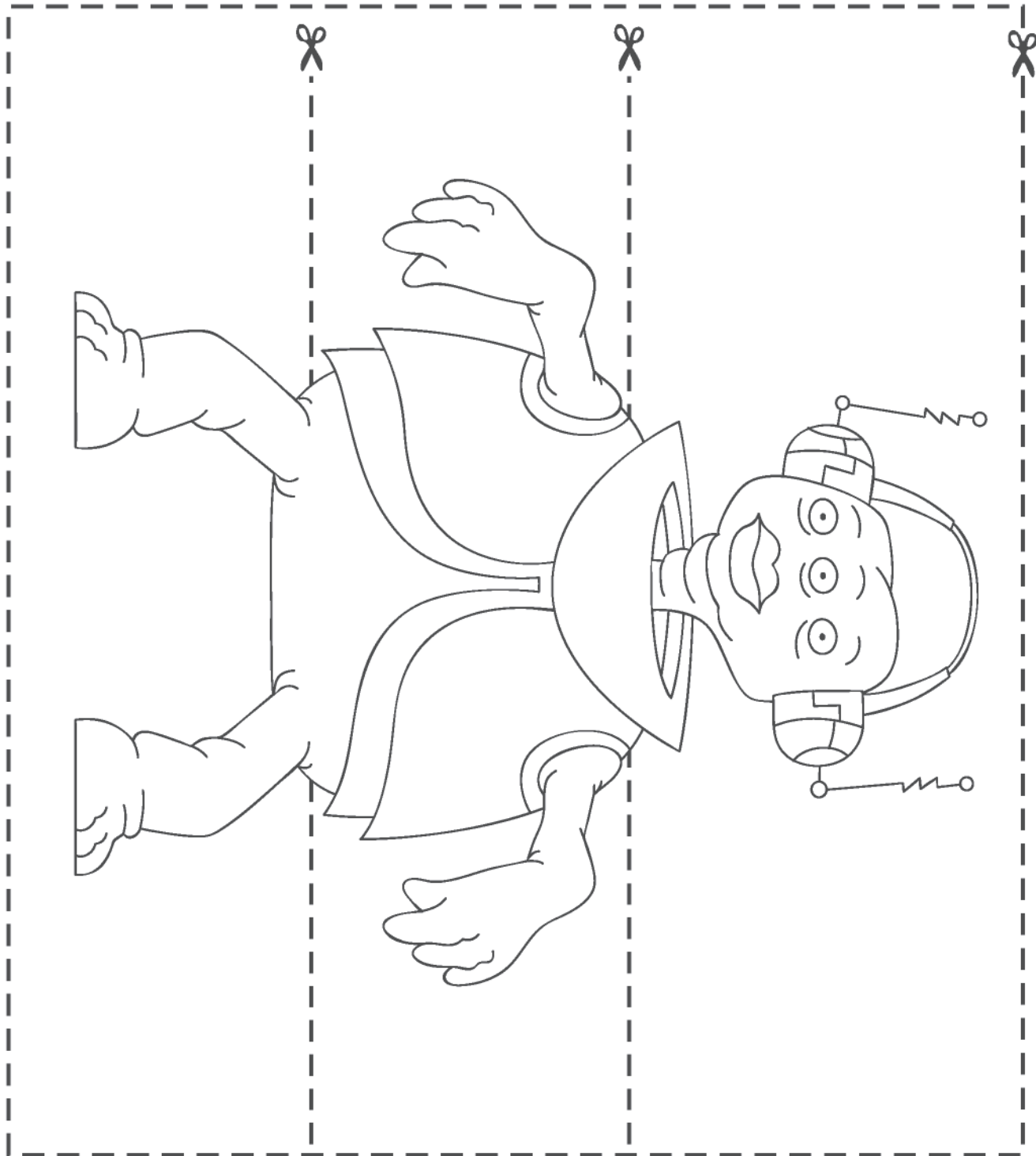



# Learn at Home with PBS KIDS

Schedule Begins May 3, 2021

Explore reading, math, science, life lessons, and more on the PBS KIDS 24/7 channel and live stream! The TV schedule below offers you and your child a chance to learn anytime alongside your friends from PBS KIDS.

TIME (M-F)	SHOW	GRADE	LEARNING GOALS
6/5c am	The Cat in the Hat Knows a Lot About That!	PK-1	Science & Engineering
6:30/5:30c am	Ready Jet Go!	K-2	Science & Engineering
7/6c am	Peg + Cat	PK-K	Math
7:30/6:30c am	Super WHY!	PK-K	Literacy
8/7c am	Daniel Tiger's Neighborhood	PK-K	Social & Emotional Learning
8:30/7:30c am	Daniel Tiger's Neighborhood	PK-K	Social & Emotional Learning
9/8c am	Sesame Street	PK-K	Literacy, Math, Social & Emotional Learning
9:30/8:30c am	Elinor Wonders Why	PK-K	Science & Engineering
10/9c am	Clifford the Big Red Dog	PK-K	Social & Emotional Learning, Literacy
10:30/9:30c am	Dinosaur Train	PK-K	Science
11/10c am	Let's Go Luna!	K-2	Social Studies
11:30/10:30c am	Nature Cat	K-3	Science
12 pm/11c am	Nature Cat	K-3	Science
12:30 pm/11:30c am	Xavier Riddle and the Secret Museum	K-2	Social & Emotional Learning
1/12c pm	Molly of Denali	K-2	Literacy
1:30/12:30c pm	Hero Elementary	K-2	Science & Engineering
2/1c pm	Cyberchase	1-5	Math & Science
2:30/1:30c pm	Pinkalicious & Peterrific	PK-1	The Arts
3/2c pm	Pinkalicious & Peterrific	PK-1	The Arts
3:30/2:30c pm	Elinor Wonders Why	PK-K	Science & Engineering
4/3c pm	Donkey Hodie	PK-K	Social & Emotional Learning
4:30/3:30c pm	Curious George	PK-K	Math, Science & Engineering
5/4c pm	Curious George	PK-K	Math, Science & Engineering
5:30/4:30c pm	Xavier Riddle and the Secret Museum	K-2	Social & Emotional Learning
6/5c pm	Molly of Denali	K-2	Literacy
6:30/5:30c pm	Hero Elementary	K-2	Science & Engineering

Access FREE, at-home learning activities, tips, and more on [pbskidsforparents.org](https://pbskidsforparents.org)



# Learn at Home with PBS KIDS

Play and learn anytime and anywhere with free apps from PBS KIDS! Use the chart below to find the app that aligns to your child's grade, learning goal, and favorite PBS KIDS show - then download it on your on your mobile or tablet device to play online, offline, or anytime.



## Apps for Social & Emotional Learning

Daniel Tiger for Parents	PK-K	Social & Emotional Learning
PBS KIDS Games app	K-2	Multiple Learning Goals
PBS KIDS Video app	K-2	Multiple Learning Goals

## Apps for Literacy Learning

Dinosaur Train A to Z	PK-K	Literacy, Science
Molly of Denali	K-2	Literacy
PBS KIDS Games app	K-2	Multiple Learning Goals
PBS KIDS Video app	K-2	Multiple Learning Goals

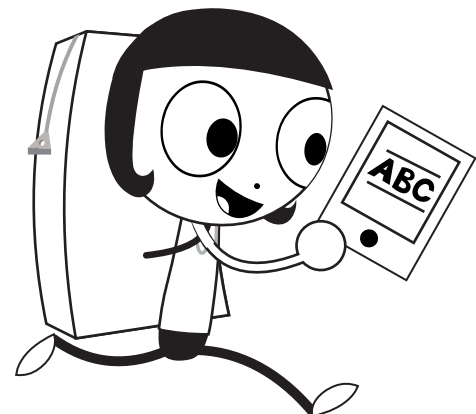

## Apps for STEM Learning (Science, Technology, Engineering & Math)

PBS Parents Play & Learn	PK-K	Literacy, Math	Ready Jet Go! Space Explorer	K-2	Science
Play & Learn Engineering	PK-K	Science and Engineering	Ready Jet Go! Space Scouts	K-2	Science and Engineering
Play & Learn Science	PK-K	Science	Nature Cat's Great Outdoors	K-3	Science
Splash and Bubbles for Parents	PK-K	Science	PBS KIDS ScratchJr	1-2	Coding
Splash and Bubbles Ocean Adventure	PK-K	Science	Outdoor Family Fun with Plum	1-3	Science and Engineering
The Cat in the Hat Builds That!	PK-K	Science and Engineering	Cyberchase Shape Quest	1-5	Math, Science
The Cat in the Hat Invents	PK-K	Science and Engineering	PBS KIDS Games app	K-2	Multiple Learning Goals
Jet's Bot Builder: Robot Games	K-2	Science and Engineering	PBS KIDS Video app	K-2	Multiple Learning Goals
Photo Stuff with Ruff	K-2	Science			

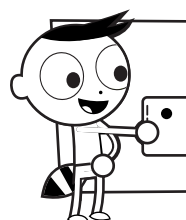

[pbskids.org/apps](https://pbskids.org/apps)

